



Declaration of Performance

No. 004HDL2013-09-01

1. Unique identification code of the product-type:

Translucent longitudinally profiled glass reinforced polyester resin sheets unlimited in length.

2. Type, batch or serial number or any other element allowing identification of the construction product as required under article 11 (4) of the COP:

Contour 3.0kg/m² (CE30 type)

3. Intended use or uses of the construction product, in accordance with the applicable harmonised technical specification, as foreseen by the manufacturer:

Light transmitting rooflight sheets (defined in accordance with NA to BS EN 1013) for discontinuously laid internal roof, wall and ceiling linings for buildings.

4. Name, registered trade name or registered trade mark and contact address of the manufacturer as required under article 11 (5):

**Hambleside Danelaw Limited
Long March
Daventry
Northamptonshire
NN11 4NR**

5. Where applicable, name and contact address of the authorised representative whose mandate covers the tasks specified in article 12 (2):

Not Applicable

6. System or systems of assessment and verification of constancy of performance of the construction product as set out in CPR, Annex V:

Not Applicable

7. In case of the declaration of performance concerning a construction product covered by a harmonised standard:

Not Applicable

8. Declared performance:

	
Hambleside Danelaw Limited 13	
EN 1013 : 2012	
Light transmitting single skin profiled Contour 3.0 (CE30 type) GRP rooflight sheet (defined in accordance with NA to BS EN 1013) for discontinuously laid internal roof, wall and ceiling linings for buildings.	
External fire performance	NPD - UK fire ratings declared separately
Reaction to fire	NPD - UK fire ratings declared separately
Water vapour permeability	1.5×10^{-5} mg/(m h Pa)
Water / air permeability	Pass
Release of dangerous substances	NPD
Dimensional tolerances	Pass
Shatter properties (safe breakability) as:	
- Small hard body impact resistance	NPD
- Large soft body impact resistance (assembly)	NPD. Performance to ACR(M)001 declared separately in accordance with NA to BS EN 1013 and NARM GN2013/1
Mechanical resistance	NPD
Flexural tensile strength	NPD
Resistance to fixings	See manufacturer's fixing instructions
Durability, as variation (after ageing):	
- of yellowness index	NPD
- of the light transmission	NPD
- on flexural strength for:	
> flexural strength, and	NPD
> flexural modulus	NPD

9. The performance of the product identified in points 1 and 2 is in conformity with the declared performance in point 8. This declaration of performance is issued under the sole responsibility of the manufacturer identified in point 4.

Signed for and on behalf of the manufacturer by:

Ray Khan – Director of Quality and Environmental Standards
(name and function)

01.10.2013
(date of issue)

(signature)



Product Safety Data Sheet

Hambleside Danelaw Limited
Long March
Daventry
Northamptonshire
NN11 4NR

Description

Light transmitting profiled sheet (defined in accordance with BS EN 1013:2012) and factory assembled GRP rooflights for discontinuously laid external roof, wall and ceiling linings for buildings.

Manufactured from translucent glass reinforced UV stable polyester with UV protective coating on the outer weather surface.

All Hambleside Danelaw products are designed and manufactured under our ISO 9001:2008 approved design, development and manufacturing system to meet the requirements of BS EN 1013:2012. They have been tested for fire retardance in accordance with BS476, and are available with fire ratings of SAA or SAB to BS476-3, Class 1 or Class 3 to BS476-7 or Class 0 to BS476-6.

Always avoid walking on rooflights at all times.

Handling

Suitable hand protection should be worn when handling GRP sheets to prevent cuts from sharp edges.

Care should be taken when handling the sheets in windy conditions as they may become difficult to handle due to the large surface area and low weight.

It is recommended that sheets are lifted onto roofs by mechanical means. Rooflights may be considered to be fragile until fully and correctly fitted and may be damaged by inconsiderate handling. It is preferable to carry sheets in the vertical position with the long edge horizontal. Special and particular care should be taken when handling FAIRs to avoid causing damage to the assembly and seals. Long units should never be lifted by the ends only or carried flat/horizontally.

Storage

All rooflights should be stored in clean dry conditions and off the ground.

For both single skin/sheet and site assembled rooflights, store on the delivery pallets or on suitable bearers spaced no more than 1.5 metres apart and keep all bearers aligned. For FAIRs store in accordance with the instructions on the pallet.

To avoid damage, all rooflights should be stored indoors or under cover. If this is not possible, install protective sheeting over the units anchored to the ground to prevent exposure to rain and direct sunlight prior to installation. All rooflights should be protected from direct sunlight prior to installation to avoid heat build-up and exposure to unprotected surfaces. FAIRs should be kept dry prior to installation to avoid any possible water ingress into the units that can cause condensation.

Installation

Hambleside Danelaw light transmitting single sheet and FAIRs GRP rooflights present no hazards to health as they are generally made to measure requiring no cutting and fixed into position with adequate natural ventilation.

If any cutting or drilling should be required by power tools in confined spaces, a build-up of airborne dust could be experienced. The Health and Safety Executive (HSE) have set Workplace Exposure Limits (WELs) for inhalable dust, for details of the limits refer to the latest edition of guidance note EH40, currently the limit for inhalable dust for long term exposure (8 hours TWA reference period) is 10mg/m³.

Should there be a possibility of exceeding the WEL, the use of a dust mask to at least FFP1 is recommended.

Skin contact with GRP dust may in some cases cause minor irritation. The dust should be washed from the skin using soapy water and if irritation persists, medical advice should be sought. This irritation can be avoided by using appropriate protective clothing and/or barrier cream.

Eye contact may cause irritation, if so flush the eye with copious quantities of clean water and seek medical attention. In line with current industry practice, always wear goggles when using powered tools.

Use

Hambleside Danelaw light transmitting single sheet and FAIRs GRP rooflights present no hazard in normal use.

Maintenance

It is recommended that rooflights and all associated fixings and seals are inspected every 2 to 3 years. Any loose or insecure fittings should be tightened or replaced as appropriate. To maintain light transmission due to soiling and to prevent any biological growth or contamination that may attack the surface protection, rooflights should be cleaned using a mild detergent in solution and a soft bristle brush; harsh chemicals or abrasive cleaners should not be used to avoid damaging the UV protective surface layer. If the protective layer is damaged it may, in some cases, be repaired with UV inhibiting clear varnish.

Fire

In case of fire, toxic gases may be given off and suitable fire fighting precautions must be taken.

Disposal

Toxicological - Inert, no hazard

Ecological – Inert, no hazard

Contact Hambleside Danelaw for the current recommended disposal route.

Rooflights and Roof Safety

The Health and Safety Executive clearly state that those persons responsible for the design of a roof structure should consider carefully the potential to eliminate or reduce the hazard if using materials that are of a fragile nature. GRP rooflights provide an effective and long term means of compliance.

ACR[M]001:2011 (Fourth Edition) Test For Non-Fragility of Profiled Sheeted Roofing Assemblies is a test of the completed roof assembly that defines the test procedure and minimum standard required to demonstrate and achieve non-fragility classification. Further guidance is contained in Guidance Note 2006/1 produced by the National Association of Rooflight Manufacturers.



Hambleside Danelaw
Building Products

Installation Instructions

Recommended Installation Instructions for Factory and Site Assembled Rooflights

HAMBLESIDE DANELAW FACTORY ASSEMBLED INSULATED ROOFLIGHT
TYPICAL CROSS SECTION

OPTION

A metal strip can be incorporated within the Rooflight underlap side to enable the use of typical stitch fasteners if required.

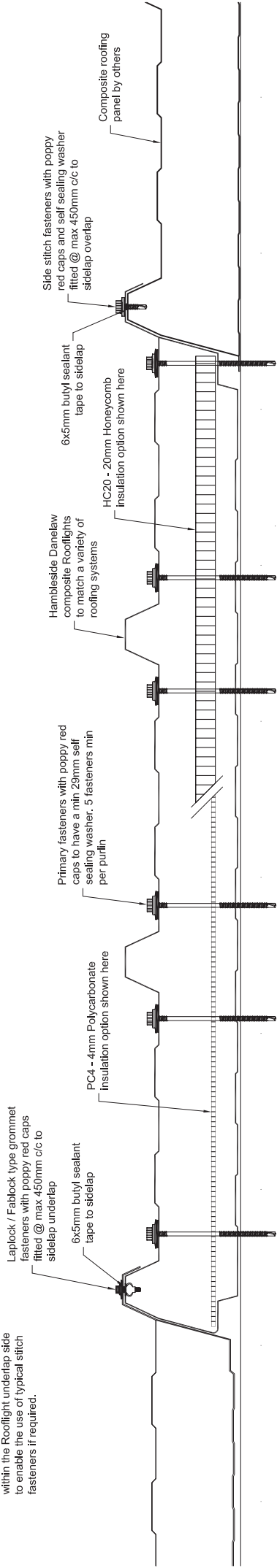

Purfin

For further guidance on the sealing of Rooflights please refer to MCRMA Technical paper 16

CLIENT	Hambleside Danelaw Ltd		
PROJECT	Typical Details		
SCALE	1:4 @ A3	DATE	01.10.2013
DRAWING TITLE	Factory Assembled Insulated Rooflights - Typical Details		
DRAWING NUMBER	FAIR-TD		
T 01327 701900 F 01327 701909 W www.hambleside-danelaw.co.uk A Long March, Davenney, NN11 4NR			

HAMBLESIDE DANELAW FACTORY ASSEMBLED INSULATED ROOFLIGHT
TYPICAL END LAPS

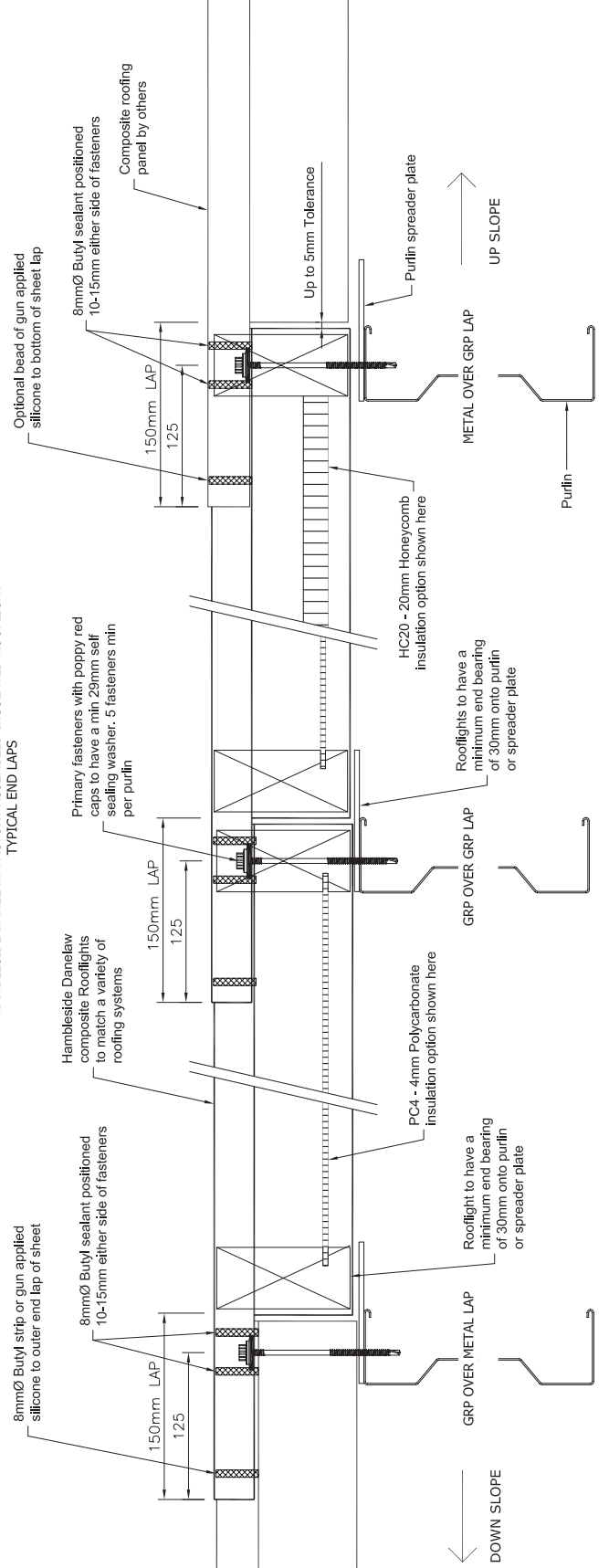

DOWN SLOPE

UP SLOPE

Purfin

HAMBLESIDE DANELAW SITE ASSEMBLED ROOFLIGHTS
TYPICAL CROSS SECTION

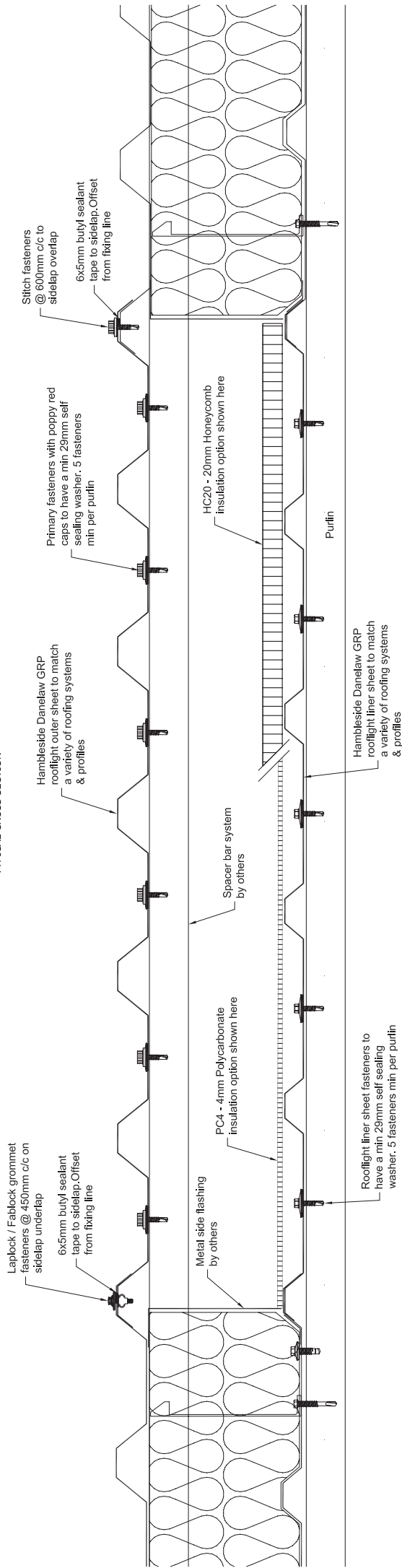

HAMBLESIDE DANELAW SITE ASSEMBLED ROOFLIGHTS
TYPICAL END LAPS

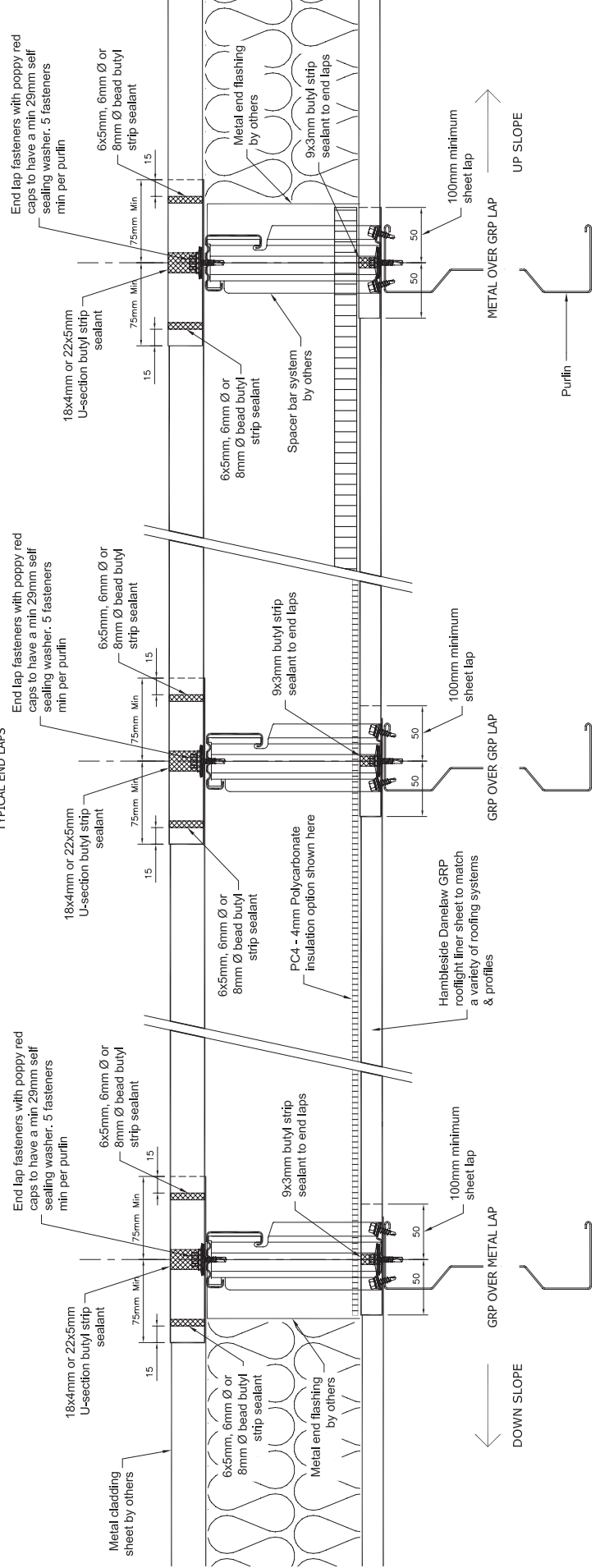

For further guidance on the sealing of rooflights please refer to MCRMA Technical Paper 16

CLIENT	HDL
PROJECT	Typical Fixing Details
SCALE	1:4 @ A3
DATE	01.10.2013
DRAWING TITLE	Site Assembled Rooflights Typical Fixing Details
DRAWING NUMBER	SAR-TD
Hambleside Danelaw Ltd T 01327 701900 F 01327 701909 W www.hambleside-danelaw.co.uk A Long March, Daventry, NN11 4NR	